

# Zuganker Tirants

Stand: 10.08

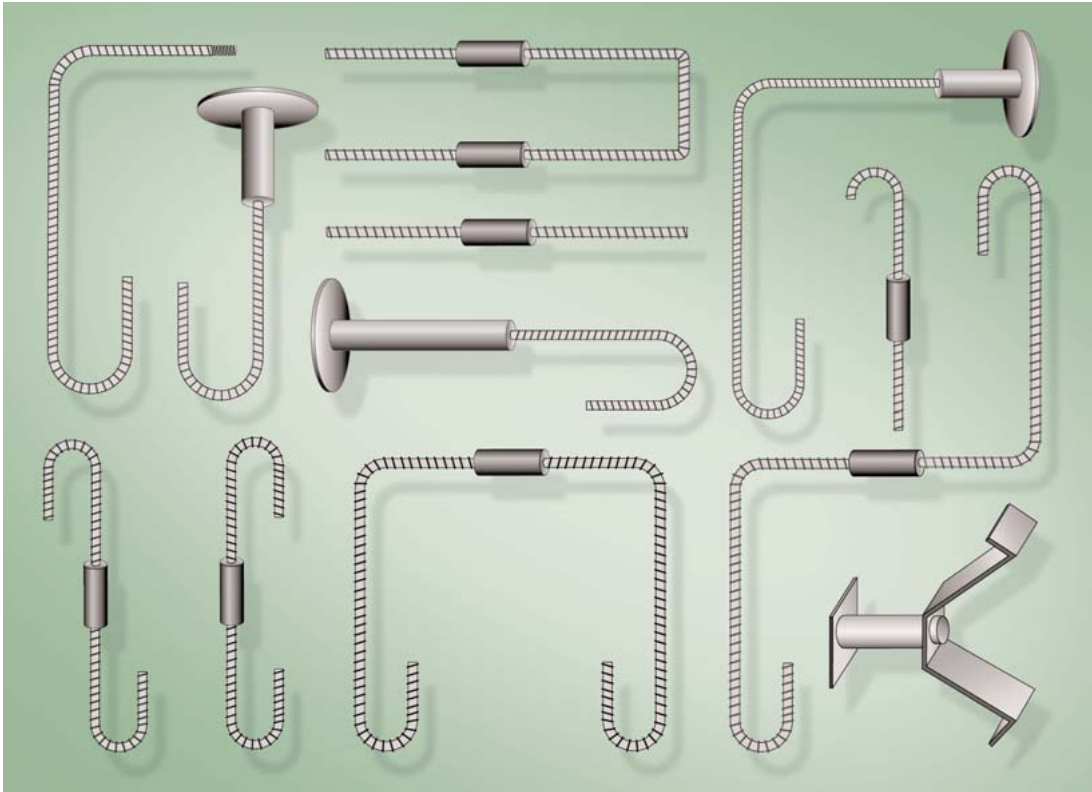

***Einfach und schnell zu verarbeiten, mit den ein- oder zweiteiligen Zuganker haben Sie die Zugkräfte im Griff.***

ANKABA Anker-technik  
und Bauhandel AG  
Zürichstrasse 38a  
CH-8306 Brütisellen  
Tel. 044 807 17 17  
Fax 044 807 17 18  
info@ankaba.ch  
www.ankaba.ch



## Zweiteilige Zuganker/Triants en deux parties

Typ/Type Z A

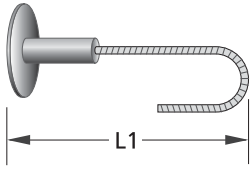

Typ/Type Z B

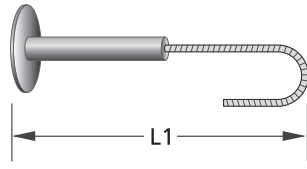

Typ/Type Z C

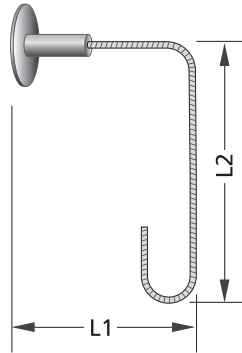

Typ/Type Z D

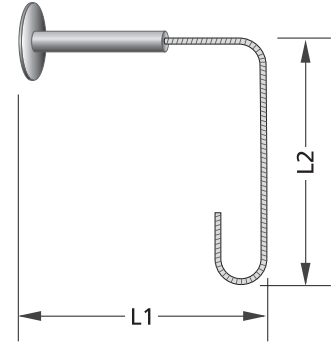

Typ/Type Z I

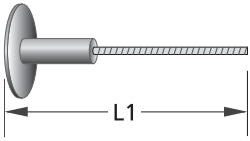

Typ/Type Z J

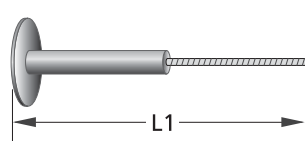

Typ/Type Z E

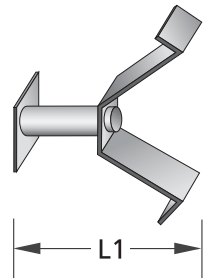

Typ/Type Z H

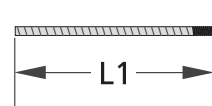

Typ/Type Z F

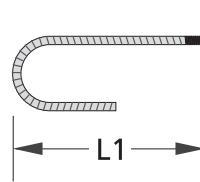

Typ/Type Z G

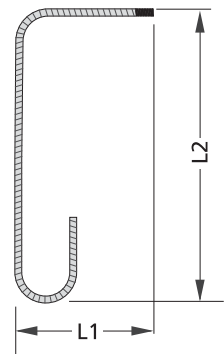

## Einteilige Zuganker/Triants en une partie

Typ/Type AS

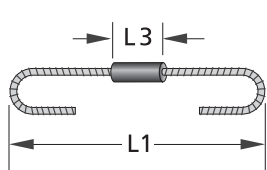

Typ/Type CS

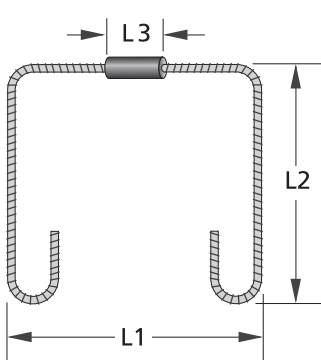

Typ/Type ES

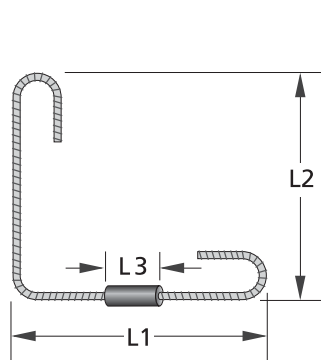

Typ/Type DS

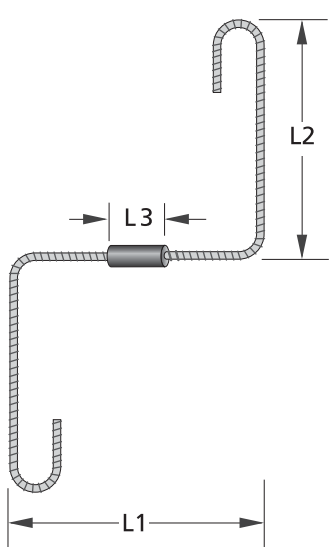

Typ/Type BS

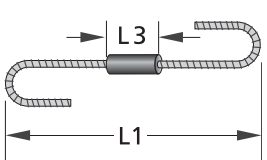

Typ/Type GS

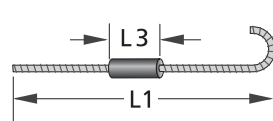

Typ/Type FS

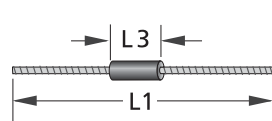

Typ/Type HS

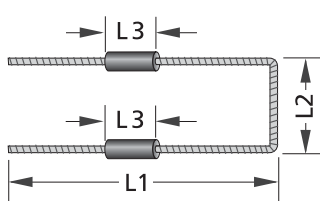

Alle Ankertypen sind in folgenden Stahlqualitäten lieferbar:  
1.4301, 1.4362, 1.4429, 1.4462, 1.4529, 1.4571